

Operating Instructions

RM-Iso

***Insulation and Loop Resistance
Measuring Module
with Capacitance Measurement
for the Rail-Module-Bus***



Contents

Technical Data	3
Ordering Data	3
General Information	4
Designated Use	4
Safety Instructions	5
Installation	6
Mounting	6
Electrical connection	7
Entering the measuring module address	8
Function/Start-up	9
Basic functions of the measuring module RM-Iso	9
Measuring module RM-Iso settings	12
Signification of the LEDs	16
The LANCIER Tx bus	17
Tx bus performance test	17
EC Declaration of Conformity	20



Important!

It is imperative to read and observe all safety instructions prior to initial operation!

© 2012 LANCIER Monitoring GmbH.

This operating instruction must not be reproduced or made available, either complete or in extracts, before the specific consent of LANCIER Monitoring GmbH.

Technical Data

Insulation resistance

Measurement range	0 .. 200 M Ω , fault ± 10 % of meas., $\pm 0,2$ M Ω
Resolution	0,1 M Ω

Loop resistance

Measurement range	0 .. 9.99 M Ω , fault ± 3 % of measurement, ± 50 Ω
Resolution	10 Ω

Capacitance

Measurement range	2500 nF, fault ± 3 % of measurement, ± 3 nF
Resolution	1 nF

Measuring voltage	90 V DC, switchable and disengageable
-------------------	---------------------------------------

Supply voltage	12 V / 5 V DC by RM-Basic module
----------------	----------------------------------

Power consumption	max. 4 W
-------------------	----------

Measurement input

Impulse stability 1,2/50 μ s	1000 V
----------------------------------	--------

Operating temperature	-20 $^{\circ}$ C .. +65 $^{\circ}$ C
-----------------------	--------------------------------------

Storing temperature	-40 $^{\circ}$ C .. +70 $^{\circ}$ C
---------------------	--------------------------------------

Admissible ambient humidity	0 .. 95 % rel. humidity, non-condensing
-----------------------------	---

Display	Monochrome LC-Display by RM-Basic module
---------	---

Signal LEDs

2 x green / red:	<i>red:</i> Alarm insulation resp. loop <i>flashing:</i> Acknowledged alarm insulation resp. loop
1 x blue:	<i>green:</i> Display insulation resp. loop display operation

Signal outputs	2 dry change-over contacts for: insulation resistance, loop resistance
----------------	---

Max. switchable voltage	100 V DC
-------------------------	----------

Max. switchable current	0.1 A DC
-------------------------	----------

Dimensions RM-Iso (W x D x H)	72 x 89 x 65 mm
-------------------------------	-----------------

Ordering Data

Measuring module RM-Iso	Order-No. 074003.100
--------------------------------	-----------------------------

Accessories

Basic module RM-Basic

Power supply and display module for the RM-Bus	Order-No. 074001.100
--	-----------------------------

Bus expansion RM-Bus-Extender

with connection cable	Order-No. 074002.000
-----------------------	-----------------------------

General Information

These operating instructions should make it easier for you to become acquainted with the product. They contain important information to ensure safe, appropriate and cost-effective use of the equipment.

The operating instructions endorse the directives of national regulations for the prevention of accidents and the protection of the environment.



These operating instructions shall be read and adopted by anyone assigned to work with/on the equipment, e. g. during operation to include setting-up, maintenance trouble-shooting.

In addition to the operating instructions and the mandatory regulations for the prevention of accidents, applicable in the operator's country and at the place of use, the recognized technical regulations for safe and professional operation shall also be observed.

Designated Use

The insulation and loop resistance sensor RM-Iso is designed to measure insulation and loop resistance as well as capacitance of communication cables.

Any other use is considered improper. The manufacturer is not liable for any resulting damage; the user alone bears the risk!

Safety Instructions



Important!

Read and observe safety instructions prior to initial operation!

- Keep the operating instructions ready to hand!



Accident prevention!

All circuit lines must be dead before the opening of its housing!

- The unit should only be operated in technically-sound condition, for its designated use, with safety and risk awareness in mind, taking into account the operating instructions. In particular, operational faults, which can compromise safety, should be rectified immediately!
- Do not make any modifications to the equipment!
- Mounting, maintenance and repair work should only be performed by trained personnel!
- Only use original LANCIER Monitoring replacement parts!



Important!

Obey handling instructions. Electrostatic discharge (ESD) damage.



WARNING!

The place of installation of the RM module should have a complete lightning protection plan that covers power supply cables as well as data and telecommunications cables.

Installation

Mounting

The Rail-Module-Bus-System is composed of a basic module and various measuring modules (1), which are clipped on a DIN rail (2). When screwing on the DIN rail (2) make sure that the spacing of the mounting screws matches the spacing of the ports on the back of the connecting plates (3).

Each measuring module (1) has a bus connecting plate (3) that plugs into the interfaces (4) of the existing neighbouring module and subsequently clips into the DIN rail (2).

The measuring module can now be attached to the Bus connecting plate (3) using opened connecting clips (5). The connecting clips (5) must be pushed in until they lock into place to secure them.

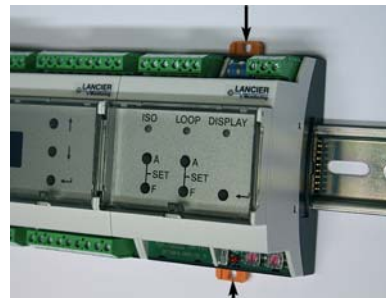
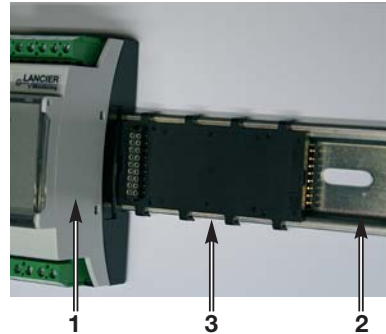
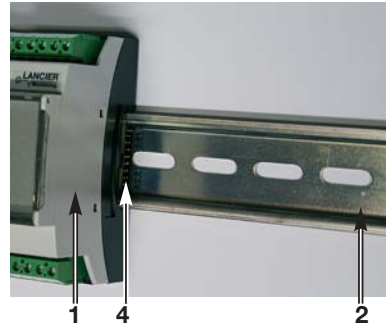

Electrical connection



Accident prevention!

Before working on the bus system the supply voltage **MUST** be switched off!



WARNING,

Adhere to EMC directives!

RM-Iso measuring modules are connected to each other using a bus connecting plate (3). Communication between modules is carried out by a CAN bus. Measurement connections are attached directly to each module.

Terminal assignment

Module

X1.1 to 3 Signal contact Iso

X1.4 to 6 Signal contact Loop

X2.1 to 3 Measuring loop (a, b – pair loop, reference ground)

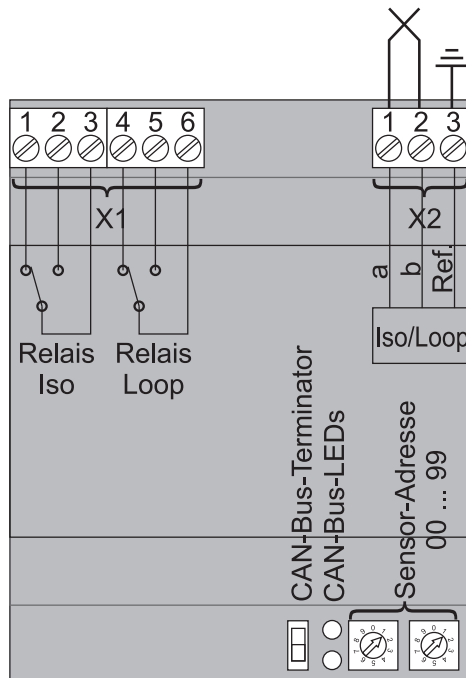

CAN bus terminator

The last participant on the RM CAN bus (as seen from the basic module) must be equipped with a terminating resistor. Next, flip the “CAN-Bus-Terminator” switch down.

Entering the measuring module address

Each RM basic module (6) can hold a maximum of 10 measuring modules (1). The measuring modules are connected to the basic module (6) on a DIN rail using a bus connecting plate or using an interface cable with the connecting plug (8).

To assign unique measurement values, the measuring modules (1) must be addressed.

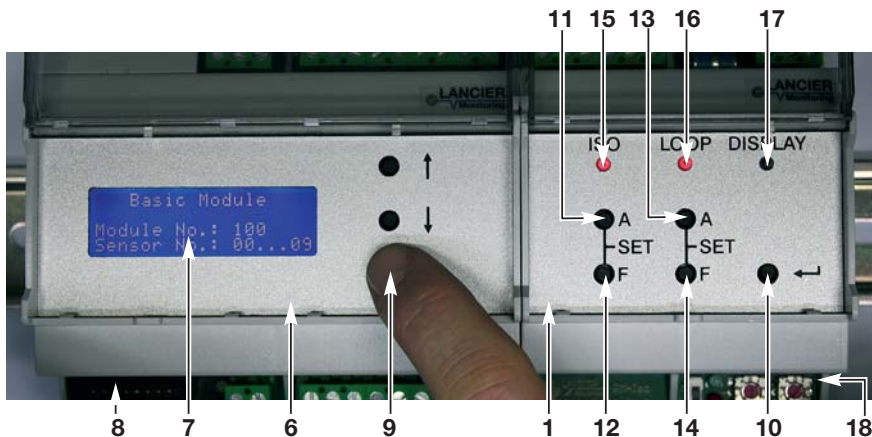

1. Determining the basic module number

Press and hold the “Enter” button (9) on the basic module for 5 s until “Module No.” appears on the display (7).

2. Reading the module No.

For the

- basic module No. 100 measuring module addresses 01 to 09 are acceptable,
- basic module No. 101 measuring module addresses 10 to 19 are acceptable, etc., until
- basic module No. 109 measuring module addresses 90 to 99 are acceptable

The basic module automatically returns to the normal display mode after a preset amount of time.

3. Entering measuring module addresses

Using a small screwdriver, enter the module number on the address rotary switch (18) (left switch in the 10th position, right switch in the 1st position).

For technical reasons the measuring module address 00 is not allowed.



10th, 1st pos.

Example: Module address 01

The measuring module address remains identical when connected to another CAN or module bus.



IMPORTANT!

After entering the measurement module addresses, the basic module should be reset by switching the power supply off and then on again.

Function/Start-up

The sensor RM-Iso is a measurement and monitoring device for insulation and loop resistance as well as capacitance in the LANCIER Monitoring RM bus. Several measuring modules are mounted to a DIN rail and, by means of integrated plug-in contacts, are directly connected to one another. The power supply, measurement value reporting and display, as well as their transmission to remote measuring stations, are carried out through the RM basic module.

Communication between the modules is carried out by a CAN bus.

A free pair in the cable that is to be monitored serves as a measuring loop, which is continuously measured by the RM-Iso module. The alarm threshold for insulation and loop resistance can be programmed with no restriction using an integrated keypad and the basic module's display. All settings are saved in an internal EEPROM memory to prevent losses.

The RM-module calculates the remaining length of the measurement loop in case of line interruption automatically if capacitance measurement is activated. This allows for a quick cable fault location due to construction works, cable theft or sabotage.

To troubleshoot, additional adjacent external voltages can potentially be measured and the polarity of the measurement voltage can be reversed.

For remote alarms, the RM-Iso has an integrated potential-free output contact.

Basic functions of the measuring module RM-Iso

1. System start/Self test

- When the power supply is switched on, the system carries out a self test, which is indicated by the display (7) on the basic module (6).

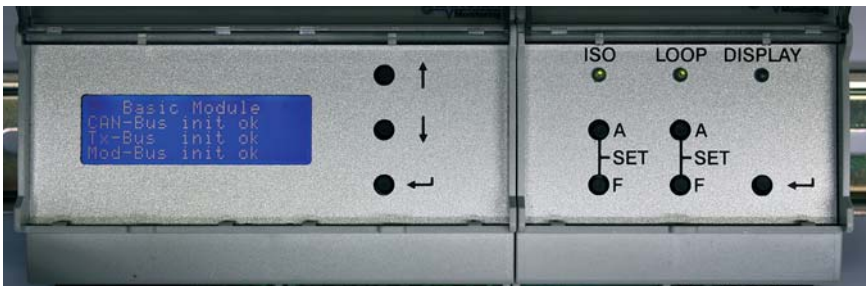

2. Measured value display

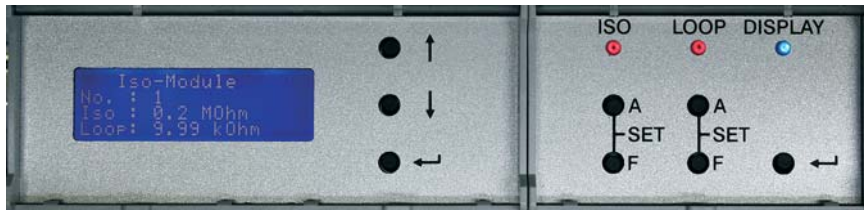

- Press the “Enter” button (10) on the measuring module (1) to show the current insulation and loop values in the display (7) on the basic module (6).
- Press the “Enter” button (10) again to show the measured capacitance, the programmed capacitance of the line and the calculated faultless line length.

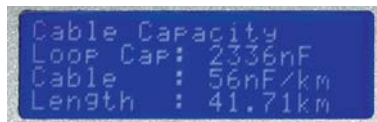

For this, capacitance measurement has to be active (see page 14), the measurement loop must be interrupted as a capacitance measurement has been carried out.

Adjacent display is shown, if the measurement loop is faultless:



- The blue “Display” LED (17) glows on the measuring module.

3. Iso threshold display / Entering threshold

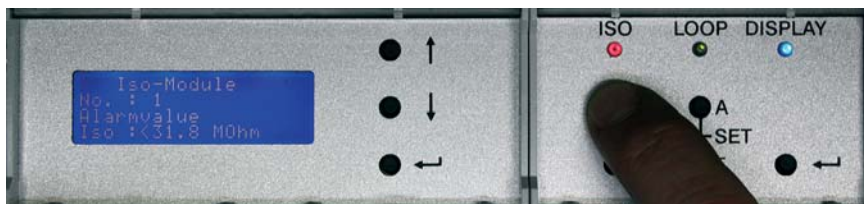

- Press the “Iso A” button (11) on the measuring module (1) to display the stored insulation threshold on the display (7) of the basic module (6).

Increasing the threshold

- Press and hold the “Iso A” button (11) on the measuring module (1) and also press the “Iso F” button (12) on the measuring module (1) until the desired value (0 to 200.0 MOhm) is reached. The longer the “Iso F” button (12) is pressed, the quicker the threshold increases. After the maximum value of 200.0 the display returns to a value of 0.0.

The new value entered is saved automatically.

4. Loop threshold display/Entering the threshold

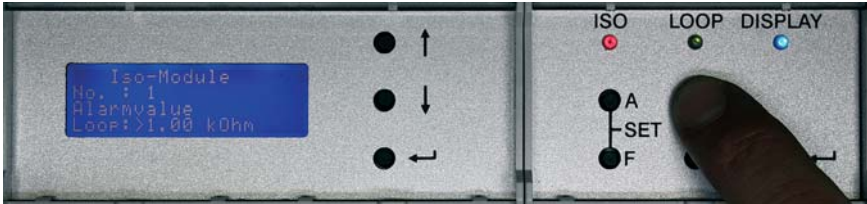

- Press the “Loop A” button (13) on the measuring module (1) to show the stored loop threshold on the display (7) on the basic module (6).

Increase the threshold

- Press and hold the “Loop A” button (13) on the measuring module (1) and also press the “Loop F” button (14) on the measuring module (1) until the desired value (0 to 9.99 kOhm) is reached. The longer the “Loop F” button (14) is pressed, the quicker the threshold increases. After the maximum value of 9.99 the display jumps back to a value of 0.0.

The new value entered is saved automatically.

Measuring module RM-Iso settings

1. Opening the service menu

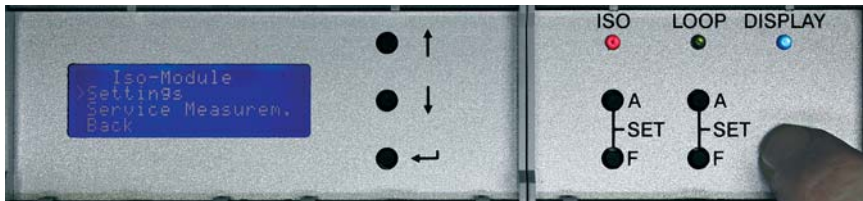

- Press and hold the “Enter” button (10) on the measuring module (1) for 5 s to call up the measuring module’s service menu on the display (7) of the basic module (6).
- Every short press of the ”Enter” button (10) on the measuring module (1) moves the selection cursor down one menu item.
- *The blue “Display” LED glows on the active measuring module.*

2. Displaying and changing the settings of the measuring module

- The cursor must be in front of the “Settings” menu item.
- Press and hold the Enter” button (10) on the measuring module (1) for 2 s to call up the settings display on the display (7) of the basic module (6). *The “No.” item always shows the number of the active measuring module.*
- Every short press of the “Enter” button (10) on the measuring module (1) calls up the following settings in succession:

1. „Average Factor”

Highly fluctuating measurement values resulting from interference voltage on the cable can be steadied by generating an average of 2 to 16 measurements.

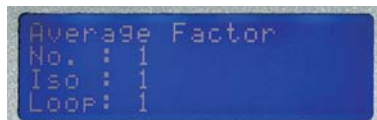

The average factor setting is carried out separately for the measurement of insulation and loop resistance.

Changing the number of measurements for the generation of an average insulation value:

- Press and hold the “Iso A” button (11), and simultaneously
- Press the “Iso F” button (12) as often as required until the desired value (1 to 16) is reached. After the maximum value of 16 the display returns to a value of 1.

Changing the number of measurement for the generation of an average loop value:

- Press and hold the “Loop A” button (13), and simultaneously
- Press the “Loop F” button (14) as often as required until the desired value (1 to 16) is reached. After the maximum value of 16 the display returns to a value of 1.

The new value entered is saved automatically.

2. „Alarm-Type”

- 0 = Measurement value > preset threshold,
relay is activated during the alarm
- 1 = Measurement value < preset threshold,
relay is activated during the alarm
- 2 = Measurement value > preset alarm value,
relay is deactivated during alarm
- 3 = Measurement value < preset alarm value,
relay is deactivated during alarm



```
Alarm-Type
No. : 1
Iso : 1
Loop: 2
```

Changing the alarm type for insulation measurement:

- Press and hold the “Iso A” button (11), and simultaneously
- Press the “Iso F” (12) as often as required until the desired value (0 to 3) is reached. After the maximum value of 3 the display returns to a value of 0.

Changing the alarm type for loop measurement:

- Press and hold the “Loop A” button (13), and simultaneously
- press the “Loop F” button (14) as often as required until the desired value (0 to 3) is reached. After the maximum value of 3 the display returns to a value of 0.

The new value entered is saved automatically.

3. „Tx-Address”

- Iso = preset Tx bus address
for insulation measurement
- Loop = preset Tx bus address
for loop measurement



```
Tx-Address
No. : 1
Iso : 1
Loop: 2
```

Changing the Tx bus address:

- The Tx bus addresses are always given in direct succession. The lower valued addresses are always valid for insulation measurement, the higher ones are valid for loop measurement, e.g., Iso = 1, Loop = 2 until Iso = 126, Loop = 127



IMPORTANT!

Make sure that the measuring module is coded with a unique address on the assigned Tx-bus to avoid data collision.

Increasing the address value:

- Press and hold the “Iso A” button (11), and simultaneously
- Press the “Iso F” button (12) as often as required until the desired value (0 to 127) is reached. After the maximum value of 127 the display returns to a value of 1.

Decreasing the address value:

- Press and hold the “Loop A” button (13), and simultaneously
- Press the “Loop F” button (14) as often as required until the desired value (127 to 0) is reached. After the minimum value of 0 the display returns to a value of 127.

Address value 0:

- The address value 0 deactivates communication by the measuring module through the Tx bus.

The new value entered is saved automatically.

4. „Cable Capacity”

State = state of capacitance measurement.

0 = no capacitance measurement

1 = capacitance measurement is activated

Loop = capacitance per km of the measurement line



Shift state of capacitance measurement:

- Press and hold the “Iso A” (11), and simultaneously
- Press the “Iso F” button (12) to shift the value between 0 and 1.

Increasing the capacitance value of the measurement line:

- Press and hold the “Loop A” button (13), and simultaneously
- Press the “Loop F” button (14) as often as required until the desired value (0 to 999) is reached. After the maximum value of 999 the display returns to a value of 0.

Decreasing the capacitance value of the measurement line:

- Press and hold the “Loop A” button (13), and simultaneously
- Press the “Iso F” button (12) as often as required until the desired value (999 to 0) is reached. After the minimum value of 0 the display returns to a value of 999.

The new value entered is saved automatically.

5. „Servicetime”

S-Time = Service time in seconds.
If service measurements have been taken (see page 13) the sensor returns to normal operation once the service time has expired.

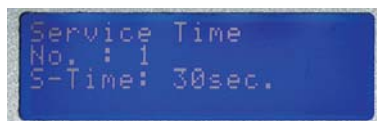

Extending service time:

- Press and hold the “Iso A” (11), and simultaneously
- Press the “Iso F” button (12) as often as required until the desired value (0 to 999) is reached. After the maximum value of 999 the display returns to a value of 0.

Reducing service time:

- Press and hold the “Loop A” button (13), and simultaneously
- Press the “Loop F” button (14) as often as required until the desired value (999 to 0) is reached. After the minimum value of 0 the display returns to a value of 999.

The new value entered is saved automatically.

6. „Software”

Version and production date of the internal software (firmware).

These values cannot be changed.

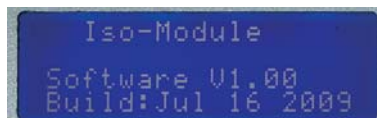

3. Service measurements

- The cursor must be in front of the “Service Measurem.” menu item.
- Press and hold the “Enter” button (10) on the measuring module (1) for 2 s to call up the service measurements display on the display (7) of the basic module (6).

The “No.” Item always displays the number of the active measuring module.

- Every short press of the “Enter” button (10) on the measuring module (1) calls up the following settings in succession:

1. „Inverse Polarity Iso”

When measuring resistance with reversed polarity, the measurement value should be the same as when measuring normally.

Discrepancies indicate an inaccurate measuring section.



```
Service
Inverse Polarity
No. : 1
Iso : 0.0 MOhm
```

2. „Inverse Polarity Loop”

When measuring resistance with reversed polarity, the measurement value should be the same as when measuring normally.

Discrepancies indicate an inaccurate measuring section.

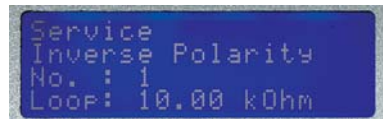

```
Service
Inverse Polarity
No. : 1
Loop: 10.00 kOhm
```

3. „External Voltage Iso”

External voltage should amount to 0 V (Display: <1.0 V).

Discrepancies indicate an inaccurate measuring section.

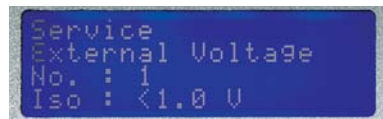

```
Service
External Voltage
No. : 1
Iso : <1.0 V
```

4. „External Voltage Loop”

External voltage should amount to 0 V (Display: <1.0 V).

Discrepancies indicate an inaccurate measuring section.

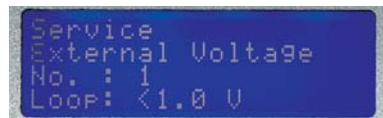

```
Service
External Voltage
No. : 1
Loop: <1.0 V
```

5. „Loop Capacity Measurement”

Capacitance measurement is running...



```
Service
Loop Capacity
Measurement
wait...
```

Measuring value, line capacitance and calculated faultfree line length are displayed in case of line interruption.



```
Service
Loop Cap: 2336nF
Cable   : 52nF/km
Length  : 44.92km
```

The module automatically returns to normal service once the service time has expired.

Signification of the LEDs

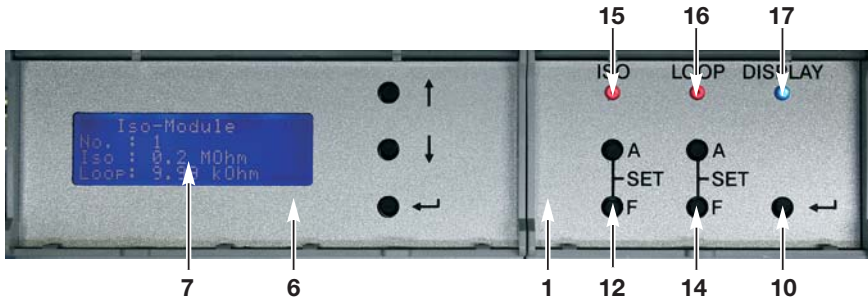

15 LED „Iso“

- glows **green** if the insulation resistance value is within the target range.
- glows **red** if the insulation resistance value is in alarm condition.
- Alternately flashes **red** and **green** if the “Iso” signal contact is acknowledged by pressing the “Iso F” button (12) but the insulation resistance value is still in alarm condition.

16 LED „Loop“

- glows **green** if the loop resistance value is within the target range.
- glows **red** if the loop resistance value is in alarm condition.
- Alternately flashes **red** and **green** if the “Loop” signal contact is acknowledged by pressing the “Loop F” button (14) but the loop resistance value is still in alarm condition.

17 LED „Display“

- glows if the “Enter” button (10) on the measuring module (1) is pressed in order to display the measurement value on the display (7) of the basic module (6).

The LANCIER Tx bus

A maximum of 127 sensors can be connected to a monitoring pair in the LANCIER Tx bus, whereby care must be taken that the RM-Iso monitors two parameters that are read in a total of two time frames in succession, i.e., the RM-Iso counts as two sensors in the Tx bus.

The capacitance value must be polled via ethernet or modbus. It is not transmissible via the LANCIER Tx-bus.

The transmission of measurement values to all sensors connected to the Tx bus happens at separate times. Therefore the sensors must be encoded before installation (see page 12) with a unique address.

Tx bus performance test

All addressable sensors must be tested for proper functioning and coding with the LANCIER Testbox (Order No. 050833.100). The necessary steps for this are described in the Testbox's operating instructions.



Warning!

To prevent later malfunctions, never start up untested sensors!



LANCIER Monitoring GmbH

Gustav-Stresemann-Weg 11
48155 Münster, Germany

Tel. +49 (0) 251 674 999-0
Fax+49 (0) 251 674 999-99
mail@lancier-monitoring.de
www.lancier-monitoring.de

EC Declaration of Conformity

We declare under our sole responsibility, that the product

Make: LANCIER Monitoring
Type: Measuring Module RM-Iso

to which this declaration refers, meets the relevant health and safety requirements of the following EC directives:

2006/95/EG Low voltage directive
2004/108/EG Electromagnetic compatibility

For proper implementation of the health and safety requirements named in the EC directives the following standard(s) and/or technical specification(s) have been consulted:

EN 60950 Safety of information technology equipment
EN 61326-1 Electrical equipment for measurement, control and laboratory use - EMC requirements (class B)

Münster, 01.09.2011

Research and Development

Managing Director