

## *Operating Instructions*

# ***RM-TH***

***Temperature and Humidity  
Measuring Module  
for the Rail-Module-Bus***



# Contents

Technical Data .....	3
Ordering Data .....	3
General Information .....	4
Designated Use .....	4
Scope of supply .....	4
Safety Instructions .....	5
Installation .....	6
Mounting .....	6
Electrical connection .....	7
Entering the measuring module address .....	8
Function/Start-up .....	9
Basic functions of the measuring module RM-TH .....	9
Measuring module RM-TH settings .....	11
Signification of the LEDs .....	13
The LANCIER Tx bus .....	14
Tx bus performance test .....	14
EC Declaration of Conformity .....	16



## Important!

It is imperative to read and observe all safety instructions prior to initial operation!

© 2012 LANCIER Monitoring GmbH.

This operating instruction must not be reproduced or made available, either complete or in extracts, before the specific consent of LANCIER Monitoring GmbH.

## Technical Data

Temperature	
Measurement range	-20 .. +70 °C
Resolution	0.1 °C
Max. fault	± 2.5 °C
Humidity	
Measurement range	0 % .. 95 % r. H.
Resolution	0.1 % r. H.
Max. fault	± 3.0 % r. H.
Supply voltage	12 V / 5 V DC by RM-Basic module
Operating temperature	-20 °C .. +65 °C
Storing temperature	-40 °C .. +70 °C
Admissible ambient humidity	0 .. 95 % rel. humidity, non-condensing
Display	Monochrome LC-Display by RM-Basic module
Signal LEDs	
green / red:	<i>red</i> : alarm temperature resp. humidity <i>flashing</i> : acknowledged alarm temperature resp. humidity
1 x blue:	<i>green</i> : display temperature resp. humidity display operation
Signal outputs	2 dry change-over contacts for: temperature, humidity
Max. switchable voltage	250 V AC
Max. switchable current	1,5 A AC
Dimensions RM-TH (W x D x H)	72 x 89 x 65 mm

## Ordering Data

### Measuring module RM-TH

for temperature and humidity, incl. sensor

**Order-No. 074004.000**

### Accessories

#### Basic module RM-Basic

Power supply and display module for the RM-Bus

**Order-No. 074001.100**

**Temperature and humidity sensor** (spare part)

with connection cable, 5 m long

**Order-No. 074096.000**

## General Information

These operating instructions should make it easier for you to become acquainted with the product. They contain important information to ensure safe, appropriate and cost-effective use of the equipment.

The operating instructions endorse the directives of national regulations for the prevention of accidents and the protection of the environment.



**These operating instructions shall be read and adopted by anyone assigned to work with/on the equipment, e. g. during operation to include setting-up, maintenance trouble-shooting.**

In addition to the operating instructions and the mandatory regulations for the prevention of accidents, applicable in the operator's country and at the place of use, the recognized technical regulations for safe and professional operation shall also be observed.

## Designated Use

The measuring module RM-TH is designed to measure temperature and humidity in rooms and cabinets.

Any other use is considered improper. The manufacturer is not liable for any resulting damage; the user alone bears the risk!

## Scope of supply

- 1 Measuring module RM-TH (1) with connecting plate (3)
- 1 Digital temperature and humidity sensor with 5 m connection cable and wall mount clamping piece (24)
- 1 Operating instructions (25)

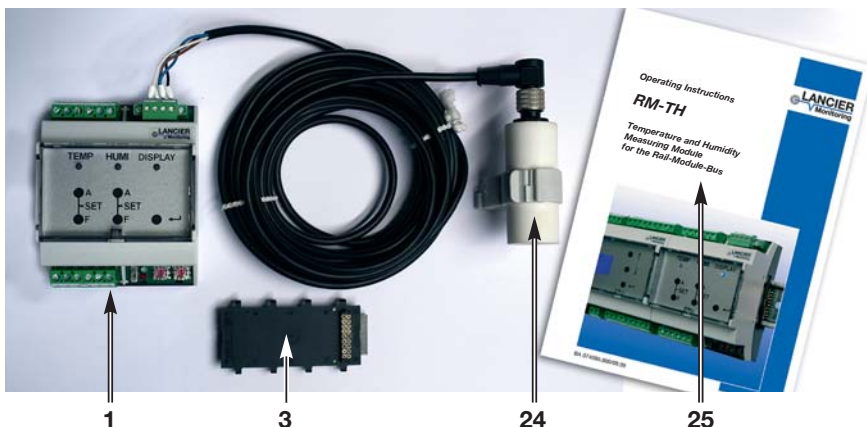

## Safety Instructions

**Important!**

**Read and observe safety instructions prior to initial operation!**

- Keep the operating instructions ready to hand!

**Accident prevention!**

**All circuit lines must be dead before the opening of its housing!**

- The unit should only be operated in technically-sound condition, for its designated use, with safety and risk awareness in mind, taking into account the operating instructions. In particular, operational faults, which can compromise safety, should be rectified immediately!
- Do not make any modifications to the equipment!
- Mounting, maintenance and repair work should only be performed by trained personnel!
- Only use original LANCIER Monitoring replacement parts!

**Important!**

**Obey handling instructions. Electrostatic discharge (ESD) damage.**

**WARNING!**

**The place of installation of the RM module should have a complete lightning protection plan that covers power supply cables as well as data and telecommunications cables.**

# Installation

## Mounting

The Rail-Module-Bus-System is composed of a basic module and various measuring modules (1), which are clipped on a DIN rail (2). When screwing on the DIN rail (2) make sure that the spacing of the mounting screws matches the spacing of the ports on the back of the connecting plates (3).

Each measuring module (1) has a bus connecting plate (3) that plugs into the interfaces (4) of the existing neighbouring module and subsequently clips into the DIN rail (2).

The measuring module can now be attached to the Bus connecting plate (3) using opened connecting cmern (5) bis zum Einrasten eingeschoben werden.

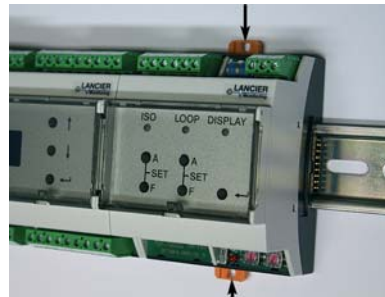
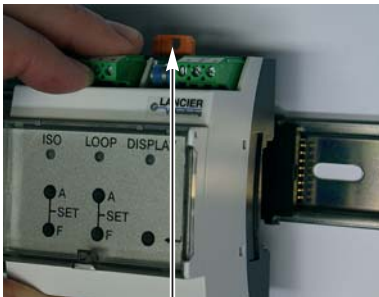
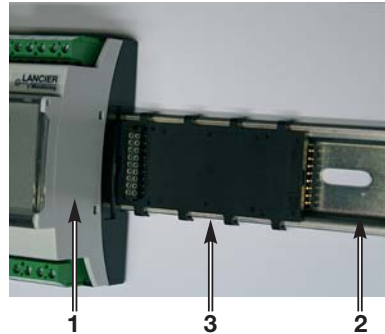
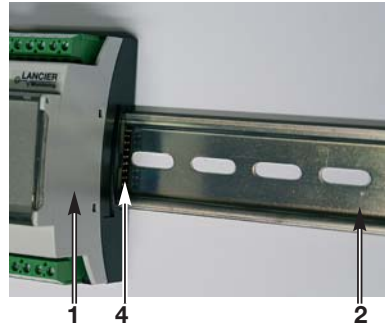

5

5

## Electrical connection



### Accident prevention!

Before working on the bus system the supply voltage **MUST** be switched off!



### WARNING,

Adhere to EMC directives!

RM-TH measuring modules are connected to each other using a bus connecting plate (3). Communication between modules is carried out by a CAN bus. The sensor is connected directly to each module.

## Terminal assignment

### Module

- X1.1 to 3** Signal contact temperature
- X1.4 to 6** Signal contact humidity
- X2.1 to 4** Digital temperature and humidity sensor
- X3.1 to 6** Optional, do not interconnect!

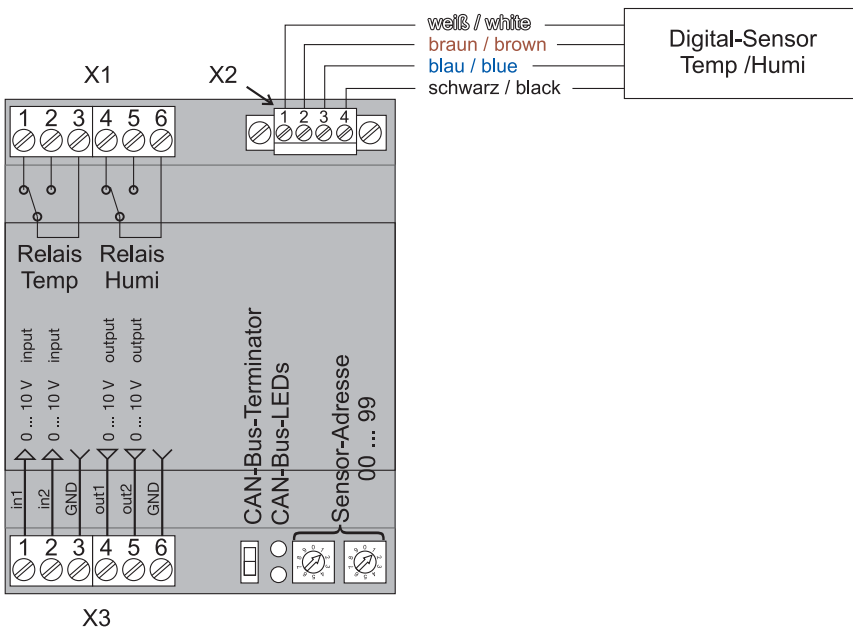

### CAN bus terminator

The last participant on the RM CAN bus (as seen from the basic module) must be equipped with a terminating resistor. Next, flip the “CAN-Bus-Terminator” switch down.

## Entering the measuring module address

Each RM basic module (6) can hold a maximum of 10 measuring modules (1). The measuring modules are connected to the basic module (6) on a DIN rail using a bus connecting plate or using an interface cable with the connecting plug (8).

To assign unique measurement values, the measuring modules (1) must be addressed.

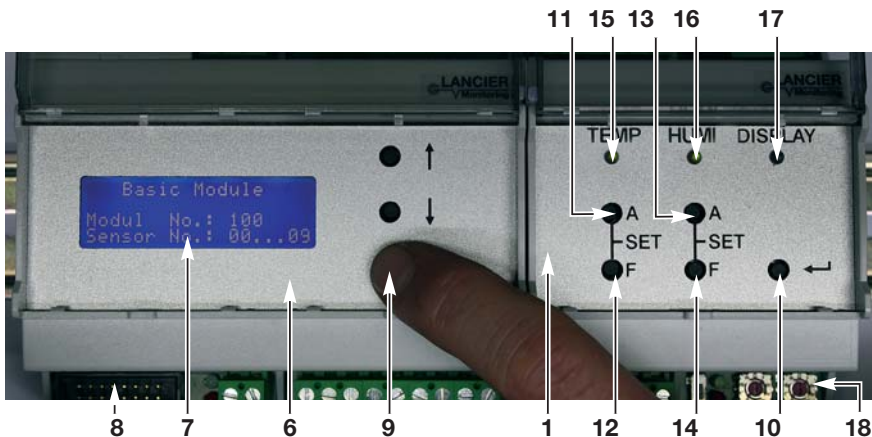

### 1. Determining the basic module number

Press and hold the “Enter” button (9) on the basic module for 5 s until “Module No.” appears on the display (7).

### 2. Reading the module No.

For the

- basic module No. 100 measuring module addresses 01 to 09 are acceptable,
- basic module No. 101 measuring module addresses 10 to 19 are acceptable, etc., until
- basic module No. 109 measuring module addresses 90 to 99 are acceptable

The basic module automatically returns to the normal display mode after a preset amount of time.

### 3. Entering measuring module addresses

Using a small screwdriver, enter the module number on the address rotary switch (18) (left switch in the 10th position, right switch in the 1st position).

For technical reasons the measuring module address 00 is not allowed.



10th, 1st pos.

Example: Module address 01

**The measuring module address remains identical when connected to another CAN or module bus.**



### IMPORTANT!

After entering the measurement module addresses, the basic module should be reset by switching the power supply off and then on again.



## Function/Start-up

The RM-TH module is a measurement and monitoring device for temperature and humidity in the LANCIER Monitoring RM bus. Several measuring modules are mounted to a DIN rail and, by means of integrated plug-in contacts, are directly connected to one another. The power supply, measurement value reporting and display, as well as their transmission to remote measuring stations, are carried out through the RM basic module.

Communication between the modules is carried out by a CAN bus.

An external digital temperature and humidity sensor is continuously measured by the RM-TH module. The alarm threshold for temperature and humidity can be programmed with no restriction using an integrated keypad and the basic module's display. All settings are saved in an internal EEPROM memory to prevent losses.

For remote alarms, the RM-TH has an integrated potential-free output contact

## Basic functions of the measuring module RM-TH

### 1. System start/Self test

- When the power supply is switched on, the system carries out a self test, which is indicated by the display (7) on the basic module (6).

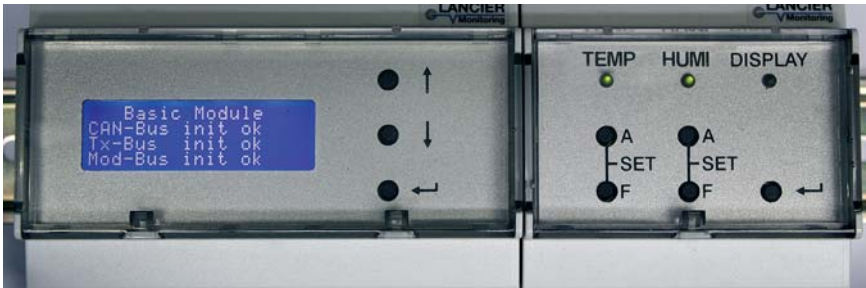

### 2. Measured value display

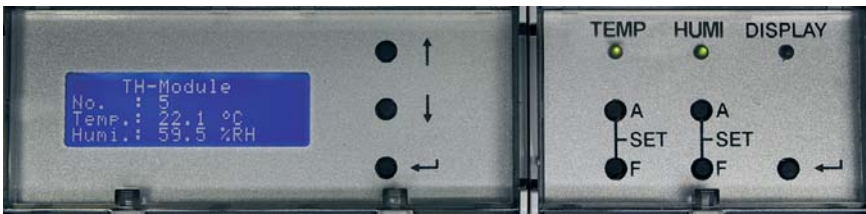

- Press the “Enter” button (10) on the measuring module (1) to show the current temperature and humidity values in the display (7) on the basic module (6).
- The blue “Display” LED (17) glows on the measuring module.

### 3. Temperature threshold display/Entering threshold

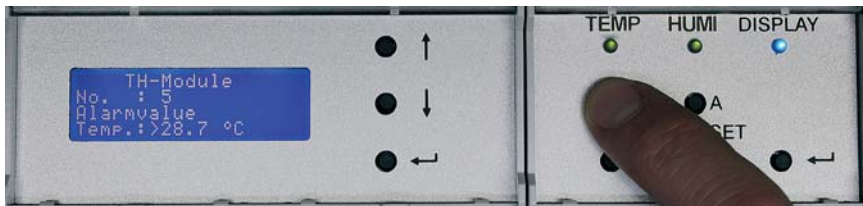

- Press the “Temp A” button (11) on the measuring module (1) to display the stored temperature threshold on the display (7) of the basic module (6).

#### Increasing the threshold

- Press and hold the “Temp A” button (11) on the measuring module (1) and also press the “Temp F” button (12) on the measuring module (1) until the desired value (-20 to +70 °C) is reached. The longer the “Temp F” button (12) is pressed, the quicker the threshold increases. After the maximum value of +70 the display returns to a value of -20.

**The new value entered is saved automatically.**

### 4. Humidity threshold display/Entering the threshold

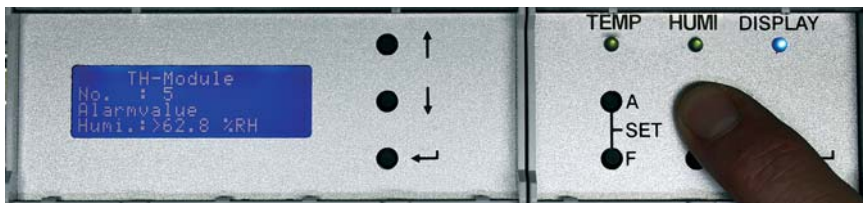

- Press the “Humi A” button (13) on the measuring module (1) to show the stored humidity threshold on the display (7) on the basic module (6).

#### Increasing the threshold

- Press and hold the “Humi A” button (11) on the measuring module (1) and also press the “Humi F” button (12) on the measuring module (1) until the desired value (0 to 100 % r. H.) is reached. The longer the “Humi F” button (12) is pressed, the quicker the threshold increases. After the maximum value of 100.0 the display returns to a value of 0.0.

**The new value entered is saved automatically.**

## Measuring module RM-TH settings

### 1. Opening the service menu

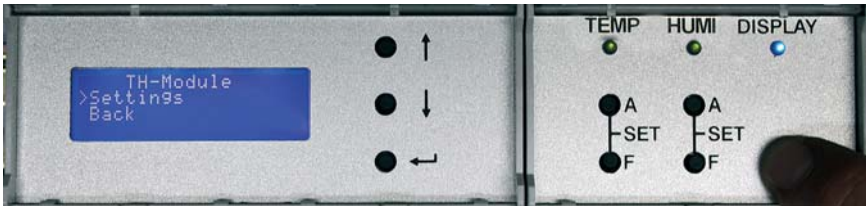

- Press and hold the “Enter” button (10) on the measuring module (1) for 5 s to call up the measuring module’s service menu on the display (7) of the basic module (6).
- Every short press of the ”Enter” button (10) on the measuring module (1) moves the selection cursor down one menu item.
- The blue “Display” LED glows on the active measuring module.

### 2. Displaying and changing the settings of the measuring module

- The cursor must be in front of the “Settings” menu item.
- Press and hold the Enter” button (10) on the measuring module (1) for 2 s to call up the settings display on the display (7) of the basic module (6). The “No.” item always shows the number of the active measuring module.
- Every short press of the “Enter” button (10) on the measuring module (1) calls up the following settings in succession:

#### 1. „Alarm-Type”

- 0 = Measurement value > preset threshold, relay is activated during the alarm
- 1 = Measurement value < preset threshold, relay is activated during the alarm
- 2 = Measurement value > preset alarm value, relay is deactivated during alarm
- 3 = Measurement value < preset alarm value, relay is deactivated during alarm



#### Changing the alarm type for temperature measurement:

- Press and hold the “Temp A” button (11), and simultaneously
- Press the “Temp F” (12) as often as required until the desired value (0 to 3) is reached.

After the maximum value of 3 the display returns to a value of 0.

#### Changing the alarm type for humidity measurement:

- Press and hold the “Humi A” button (13), and simultaneously
- press the “Humi F” button (14) as often as required until the desired value (0 to 3) is reached.

After the maximum value of 3 the display returns to a value of 0.

**The new value entered is saved automatically.**

## 2. „Tx-Address“

Temp = preset Tx bus address  
for temperature measurement  
Humi = preset Tx bus address  
for humidity measurement



```
Tx-Address
No. : 0000
Temp. : 0000
Humi. : 10
```

### Changing the Tx bus address:

- The Tx bus addresses are always given in direct succession. The lower valued addresses are always valid for temperature measurement, the higher ones are valid for humidity measurement, e.g., temperature = 1, humidity = 2 until temperature = 126, humidity = 127



### IMPORTANT!

**Make sure that the measuring module is coded with a unique address on the assigned Tx-bus to avoid data collision.**

### Increasing the address value:

- Press and hold the “Temp A” button **(11)**, and simultaneously
- Press the “Temp F” button **(12)** as often as required until the desired value (0 to 127) is reached. After the maximum value of 127 the display returns to a value of 1.

### Decreasing the address value:

- Press and hold the “Humi A” button **(13)**, and simultaneously
- Press the “Humi F” button **(14)** as often as required until the desired value (127 to 0) is reached. After the minimum value of 0 the display returns to a value of 127.

### Address value 00:

- The address value 00 deactivates communication by the measuring module through the Tx bus.

**The new value entered is saved automatically.**

## 5. „Software“

Version and production date of the internal software (firmware).

**These values cannot be changed.**

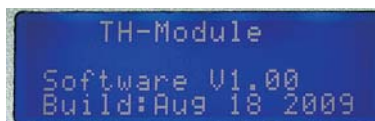

```
TH-Module
Software V1.00
Build:Aug 18 2009
```

## Signification of the LEDs

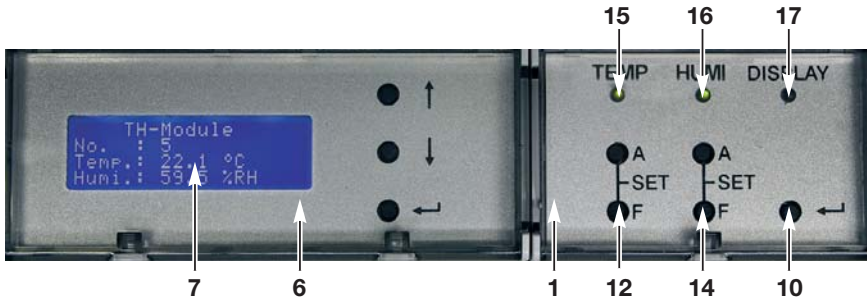

### 15 LED „Temp“

- glows **green** if the temperature value is within the target range.
- glows **red** if the temperature value is in alarm condition.
- Alternately flashes **red** and **green** if the “Temp” signal contact is acknowledged by pressing the “Temp F” button (12) but the temperature value is still in alarm condition.

### 16 LED „Humi“

- glows **green** if the humidity value is within the target range.
- glows **red** if the humidity value is in alarm condition.
- Alternately flashes **red** and **green** if the “Humi” signal contact is acknowledged by pressing the “Humi F” button (14) but the humidity value is still in alarm condition.

### 17 LED „Display“

- glows if the “Enter” button (10) on the measuring module (1) is pressed in order to display the measurement value on the display (7) of the basic module (6).

## The LANCIER Tx bus

A maximum of 127 sensors can be connected to a monitoring pair in the LANCIER Tx bus, whereby care must be taken that the RM-TH monitors two parameters that are read in a total of two time frames in succession, i.e., the RM-TH counts as two sensors in the Tx bus.

The transmission of measurement values to all sensors connected to the Tx bus happens at separate times. Therefore the sensors must be encoded before installation (see page 12) with a unique address.

## Tx bus performance test

All addressable sensors must be tested for proper functioning and coding with the LANCIER Testbox (Order No. 050833.100). The necessary steps for this are described in the Testbox's operating instructions.



### **Warning!**

**To prevent later malfunctions, never start up untested sensors!**





**LANCIER Monitoring GmbH**

Gustav-Stresemann-Weg 11  
48155 Münster, Germany

Tel. +49 (0) 251 674 999-0  
Fax+49 (0) 251 674 999-99  
mail@lancier-monitoring.de  
www.lancier-monitoring.de

## EC Declaration of Conformity

We declare under our sole responsibility, that the product

**Make:** LANCIER Monitoring  
**Type:** Interface Module RM-TH

to which this declaration refers, meets the relevant health and safety requirements of the following EC directives:

**2004/108/EG**      **Electromagnetic compatibility**

For proper implementation of the health and safety requirements named in the EC directives the following standard(s) and/or technical specification(s) have been consulted:

**EN 61326-1**      **Electrical equipment for measurement, control and laboratory use - EMC requirements (class B)**

Münster, 05.04.2012

  
Research and Development

  
Managing Director